

DR-S SERIES VALVE

Plug and Play

The Drop-In Replacement Series

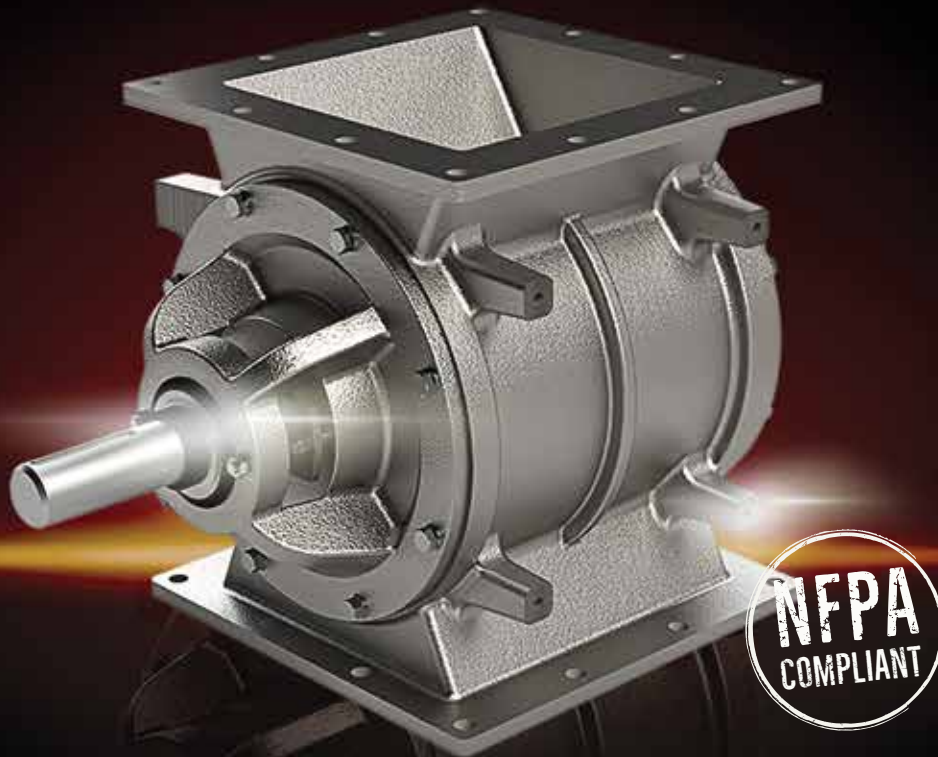

ACS
VALVES

INDUSTRIES

Every industry has its own manufacturing priorities, challenges and regulations. We continue to design new add-on features to accommodate these specific manufacturing environments and industry regulations.



DR-S SERIES VALVE

Keep Your Process Rolling

With all the application-specific advantages of a custom valve, the DR-S Series valve installs quickly with precise alignment — no matter what type of valve it's replacing. Drop it in for better performance and longevity with CNC-machined housings cast in North America.

COMPLIANT PARTS

NFPA safety and OSHA compliance is not an opt-in feature. It's a must have. Some of our safety features include: ACS RotorRail™ Quick-Clean feature, Outboard bearing design, U-shaped rotor pockets, 8-vanes for flame isolation, OSHA drive guard, Discharge flange guard.

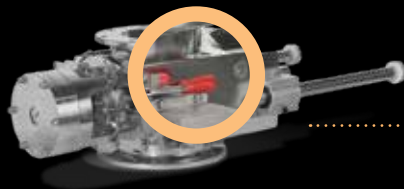

ROTOR OPTIONS

NUMBER OF POCKETS Our rotors come in various sizes with beveled tips and sides to ensure maximum efficiency in any application.

8-VANE | 10-VANE | 12-VANE

ADJUSTABLE TIPS. For adjustable tip rotors, there are a range of tips from polyurethane to mild steel.



TEMPERATURE

Is it getting hot in here? Our valves have excellent performance in high temperature applications up to 750 degrees F.

750°F

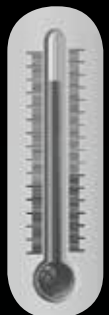

ROTOR TYPES

Our suite of rotors work with the demands, challenges and regulations involved with a wide range of materials. Choose the rotor that's right for your valve.

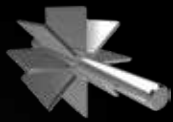

Radius Pocket Rotor



Open End Rotor

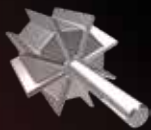

Reduced Volume Rotor

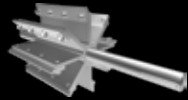

Adjustable Rotor



Flex Tip Style Rotor



Closed End Rotor



Metering Rotor

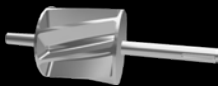

Helical Rotor

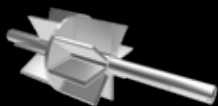

Staggered Pocket Rotor

MATERIAL TYPES

Valves of steel (and other materials of your choosing). You wouldn't convey chemicals with a cast iron valve at the risk of corrosion and ruining literally everything. Here are some practical alternatives:

- stainless steel 304, 304L, 316, 316L
- 2205 stainless steel
- Cast Iron

SIZES

HEIGHT: Available in 3 heights from 12"H to 18 1/4"H
FLANGE: 3 square-flange sizes from 7 5/8" to 11 1/4"
 We can modify valve sizes to accommodate requests.

MOTOR OPTIONS

Give your application some drive with motors from Direct Drive, Mill & Chemical and Wash Down Duty.

SEAL TYPES

So well built, our seals might as well be in the Navy. Choose between our ACST-4™ glandless Teflon® shaft seal or packing gland style seals.



PRESSURE DIFFERENTIAL

Scalability for valves that won't crack under pressure. Up to 15 PSIG. Super-duty series up to 22 PSIG.



15 → **22**
 PSIG PSIG

ACCESSORIES

THE MISSING PIECES.

- Shear Pin Sprocket
- Shear protector
- Blow Through adapter
- Air purge connections
- Rotor pocket purge connections
- Housing vent port

INTERIOR COATINGS & POLISH

Judging a valve by its cover, because your material deserves the best. Our valves handle abrasive material better than HR, but they also handle lighter material with care. We have a range of coatings and polishes from hard chrome to 180 grit finishes depending on your industry.

Need more information?

There is an endless combination of options available for our DR-S Series Valves. As such, it was impossible for us to fit all of them into this brochure. If you're interested in more information on our built-to-order valves, check them out at the link below.

acsvalves.com

The logo for ACS Valves, featuring the letters "ACS" in a large, bold, sans-serif font above the word "VALVES" in a smaller, bold, sans-serif font, all contained within a white square.

ACS
VALVES